

automatic cable rewriter FT / FTE 260/ EFT265 installation and operating instruction



INTRODUCTION

All information necessary for a correct assembly to ensure trouble free operation of the cable reel are described in the present operating instructions. The warranty given by the manufacturer is only valid if these operating instructions are observed and adhered to. Terms and conditions are available upon request or at <https://www.schill.de/en/footer/general-terms>.

Additional user manuals for other product variants can be found at <https://www.schill.de/en/downloads> or received on request (see "CONTACT").

GENERAL

Automatic cable rewriter provide for a modern power supply of workstations or the perfect supply of electrical energy, data and signals for mobile devices. The cable is only pulled out when needed and in the required length. The remainder stays neatly stored on the cable reel and is protected from contamination and damage. The power connection is always accessible, but never in the way. The cable length can be easily adapted to a changing work situation. There is no cable chaos, no tripping hazard anymore. If the cable connection is no longer needed, a short pull on the cable stopper will suffice and the cable will roll up neatly. The automatic cable rewriter provides safety and order.

HANDLING

The coiled cable should be pulled out to the required length against the spring tension, but please refrain from the use of undue force. The cable is coiled and fixed in position as described under "LOCKING DEVICE". The cable should never be pushed in manually. If the cable becomes entangled when winding it onto the reel, simply pull the cable out again and then rewind.

MAINTENANCE

The cable reel does not require any maintenance, due to the excellent antifriction properties of the plastic bearing. However, the cable must be checked in regular intervals for damages and replaced if necessary (see "EXCHANGING THE PULL-OUT CABLE").

CONTINUOUS OPERATION

The cable reel is designed for manual use in workshops. The standard cable reel is fitted with a standard available cable. If used for automated applications when a high degree of mobility is required, the standard applied cable has limitations. A special cable with a support core should be used in those applications. In order to ensure a reliable function, the cable lengths must be reduced by at least 1/3. If you consider automated applications, please contact the manufacturer up-front (see "CONTACT").

SPIRAL SPRING

The spiral spring is subject to natural wear and tear and can result in a fatigue fracture of the spring steel. Based on experience, we recommend changing the spring after approx. 30.000 operations. The term "operations" defines not only a complete winding and unwinding of the spring but also includes a partial movement of the spring. For a safe replacement of the coil spring, please refer to paragraph ("REPLACING THE SPIRAL SPRING").

CABLE STOPPER

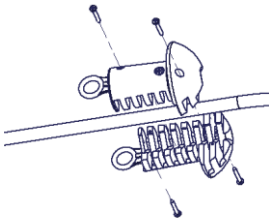

The length of the available cable can be individually adjusted with the provided cable stopper. The reliable clamping adapts to various cable diameters between 6 and 12 mm. For a thicker cable, a larger version is available. The stopper also serves as a safeguard against retraction of the cable in case of a not intended release. It should therefore never be removed.

LOCKING DEVICE

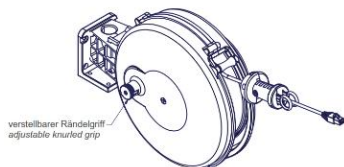

As a standard feature the cable reel has a disengageable cable locking device. The latching mechanism ensures that the pulled-out cable stays without traction fixed in place. When the cable is being pulled out, the spring detent passes over a series of grooves. An audible click indicates that the locking device is engaged. If you gently rewind the cable after the clicking sound, you will notice that the spring detent will engage into the notches, locking the cable in position. The cable can be disengaged by gently continuing to pull the cable until the click can no longer be heard. The tensioned spring will pull the cable back onto the reel.

The locking device **FT / FTE 260** can be disengaged by pulling the knurled grip out by approx. 1 cm and turning it between 90° and 180°. This will disengage the locking device the cable is then constantly under tension.

ATTENTION

Do not release the cable when rewinding, the tension of the spring can accelerate the winding speed to such a degree that the swinging cable end could cause injury. Also damage to the cable and spring could be the result of such an action.

CONNECTING THE CABLE REEL

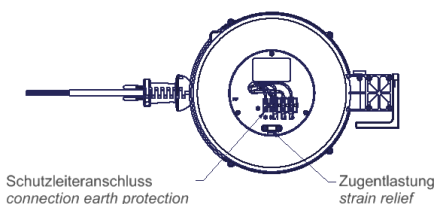

The cable reels are unless otherwise agreed supplied without connection cable. The connection cable can be mounted in a individual length to the internal fuse terminal according to the sketch above.

ATTENTION

Make sure the yellow / green earth wire is connected to the fuse terminal marked with the grounding mark and the strain relief is tightened.

EXTENSION CABLE

The included standard cables are designed to tolerate the weight of the pulled-out cable including the cable stopper. Additional weights are not allowed. The mounted cables are limited to the specified lengths. Never use excessive force to unwind the cable as this can damage both the cable and the reel. Should the cable be blocked while coiling up, please pull the cable out again and recoil. Attention should also be paid to section „GENERAL" and "CONTINUOUS OPERATION".

In the case of versions without pull-out cables, the cable is connected as described under "" EXCHANGING THE PULL-OUT CABLE"

THERMAL SAFETY GUARDS

In order to avoid an overheating of the cable reel, depending of the product version varying safety methods are used.

- The maximum payload is reduced by a 10A special glass bulb fuse. In the single-phase version, the phase is fused. On the three-phase versions all three phases are fused. The glass tube fuse is seated in the terminal block.
- If the use of 16A is relevant a self-retaining thermal switch for the single-phase versions can be implemented. If activated the power supply will be cut out. The power supply can be re-started by pressing the button after a cool down time.
- the nominal current can be reduced by a 10A fuse within the distribution box.

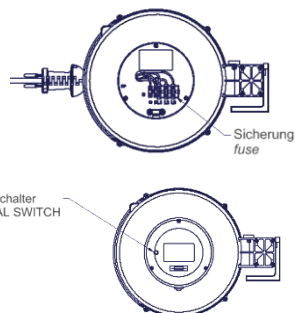

LOAD

Please refer to the details on the product label or if the cable is fitted by yourself, please adhere to the details supplied by DIN EN 50565-1 regarding the performance of the used cable.

READY FOR USE

Before commissioning, please conduct an electrical check according to the relevant applicable national standards. After connecting the cable reel to the grid and a power connection has been made, the cable reel should be live.

If this is not the case, please check the thermal safety guards (see "THERMAL SAFETY GUARDS").

TECHNICAL DATA

Our cable reels with their robust design are made for operating in factories and workshops. The sturdy plastic design, made from high-quality materials, is completely electrically insulated, corrosion resistant and has very good winding characteristics. The cable reels come as a standard without connection cable and plug-in device.

- Spiral spring for approx. 30. 000 operations
- Cable locking device (disengageable only FT/FTE versions) with spring detent
- Slip ring depended on versions:
 - Data slip ring 240V AC / 2A
 - High quality flat slip rings 240 / 400V AC - 16A with double contacts
- Versions with thermal safety guards:
 - Fuse installed DIN EN 50565-1
 - Self-retaining thermal guard (56°C±5°C)
- Cable stopper with segmented gentle clamp 6 – 12 mm
- Universal holder for wall or ceiling installation
- Ambient temperature range -25°C bis 40°C
- IP classification IP 20
- Protection class II

The stated operating temperatures relates only to the standard cable reel as described below. Specification for plug in devices can be found within the relevant standard DIN EN 60390.

Additional information with respect to cable types, spring tensions, power loads and weights can be found on the product rating plate, in our current product catalogue and on our website <https://www.schill.de/en/>

EXCHANGING THE PULL-OUT CABLE

- Disconnect the cable reel from the power supply and remove from the operation site.
- Remove the cover for the connecting terminals.
- **FT / EFT** disconnects the stranded wires of the upper slip ring from the fuse terminals. **FTE** disconnect the stranded wires of the upper slip ring from the hexagon screw.
- Loosen all the screws and remove the housing cover.

ATTENTION

The spiral spring in the coil is under tension. Please ensure that the locking mechanism is activated.

- Carefully pull the upper slip ring off the plastic axle.
- To replace the pull-out cable, you should make sure the spring is unwound for your own safety! Please adhere to the following instruction:
 1. Carefully pull on the cable stopper until the click of the notches have faded, you immediately notice a pull on the cable stopper in the opposite direction.
 2. Let the coil run back slowly and count the number of turns. This is important to adjust later the exact preload on the spring again, without damage to coil or spiral spring. In the end the coil should be able to move freely.
 3. Remove completely the damaged cable from the coil.
 4. Unscrew the slipring (lower part) turn the slip ring over and disconnect the cable.
 5. Remove strain relief inside the coil.
 6. Remove defective pull-out cable.
 7. Remove the cable stopper and where appropriate the heat shrink tubing from the defective cable and attach to the new cable.
- Undertake the re-assembly in reverse order (see "TIGHTENING TORQUE").
- Adjust the pre-load:
Hold the stopper outside the housing and hold it with one hand. Now turn the coil as often as you counted. At the end let it snap into the notches (see "LOCKING DEVICE").
- After the complete re-assembly undo the locking. Pull on the cable stopper, wind out the cable complete and slowly rewind it.
- Before re-mounting at the operation area, please check for a correct performance. (see "READY TO USE").

EXCHANGING THE SPIRAL SPRING

- Disconnect the cable reel from the power supply and remove from the operation site.
- Remove the cover for the connecting terminals.
- **FT / EFT** disconnects the stranded wires of the upper slip ring from the fuse terminals. **FTE** disconnect the stranded wires of the upper slip ring from the hexagon screw.
- Loosen all the screws and remove the housing cover.

ATTENTION

The spiral spring in the coil is under tension. Please ensure that the locking mechanism is activated.

- Carefully pull the upper slip ring off the plastic axle.
- To replace the pull-out cable, you should make sure the spring is unwound for your own safety! Please adhere to the following instruction:
 1. Carefully pull on the cable stopper until the click of the notches have faded, you immediately notice a pull on the cable stopper in the opposite direction.
 2. Let the coil run back slowly and count the number of turns. This is important to adjust later the exact preload on the spring again, without damage to coil or spiral spring. In the end the coil should be able to move freely.
- Turn the drum and release the coil from the housing by undoing the centre screw.
- Put the coil on the side with the spring cover disc top. Remove the spring cover disk.
- Remove the plastic axle.
- Remove the defective spring.

ATTENTION

Due to the manufacturing design the spring is under tension and could unwind very fast and cause injuries if handled improper.

- Carefully Re-assemble the coil. Undertake the Re-assembly in reverse order (see "TIGHTENING TORQUE").
- If necessary, wind down the pull-out cable completely by turning the coil and insert the new spring. **Pay attention to the installation position!**
- Insert the new spring. **Pay attention to the installation position!**
- Reinsert the plastic axle and assemble the spring cover disc. Ensure the retainer pin is engaging the spring eye.
- Adjust the pre-load:
Hold the stopper outside the housing and hold it with one hand. Now turn the coil as often as you counted. At the end let it snap into the notches (see "LOCKING DEVICE").
- After the complete re-assembly undo the locking. Pull on the cable stopper, wind out the cable complete and slowly rewind it.
- Before re-mounting at the operation area, please check for a correct performance (see "Ready to use").

INSTALLATION HEIGHT

The installation height of the cable rewriter is not limited. The maximum extension length is the specified cable length. The standard cables are designed to withstand the weight of the extended cable included cable stopper. Additional tensile forces (cause by additional weights for example) are not permitted.

When the cable is pull-out horizontally due to the weight of cable a slack occurs. This is about 10% of the cable pull-out length.

FITTING INSTRUCTIONS

Wall installation with universal holder DWB260

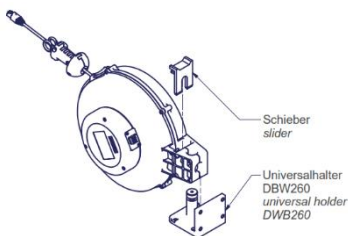

The cable reel can be rotated 150°.



PLEASE NOTE

The cable reel housing must be pushed onto the universal holder pin, then insert the slider into the intended position of the cable reel housing.

automatic cable rewriter FT / FTE 260/ EFT265 installation and operating instruction

Ceiling installation with universal holder DWB260

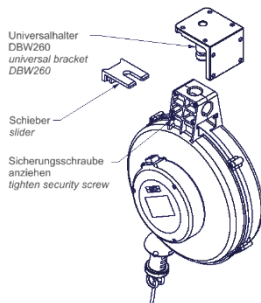

The cable reel can be rotated 360 °.

⚠ PLEASE NOTE

The cable reel housing must be pushed onto the universal holder pin, then insert the slider into the intended position of the cable reel housing.
Do not forget to fix the slider with the securing screw!

⚠ ATTENTION

If repeated over-tightening, the connection cable can be mechanically stressed and torn off.

universal holder DWB260 with slider

The DWB 260 universal holder is included in the scope of supply.

the EST 265 is screwed to the mounting surface via 4 holes on the housing.

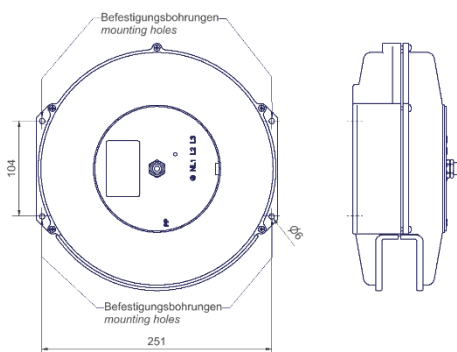
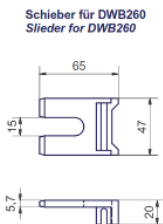
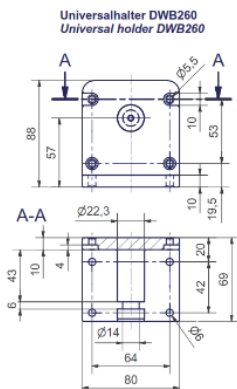

DIMENSIONS

FT / FTE 260

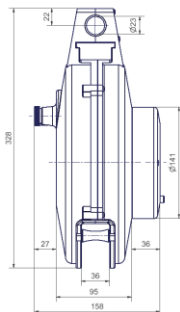
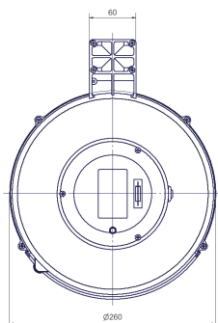

EFT265

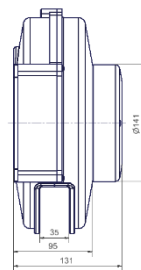
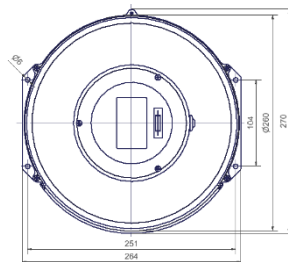

The dimensions, weights, lengths, colours and traction are subject to modifications. We cannot rule out discrepancies and we reserve the right to make technical changes to the product without giving advance notice.

automatic cable rewriter FT / FTE 260/ EFT265

installation and operating instruction

TIGHTENING TORQUE

Gehäuseschrauben <i>cover screws</i>	0,8 Nm
Achsschraube <i>axle screw</i>	1 Nm
Zugentlastung <i>strain relief</i>	0,8 Nm
Kabelstopper <i>Cable stopper</i>	0,8 Nm

elektrische Anschlüsse <i>electrical connections</i>	0,5 Nm
MS-Schleifring Mutter M3,5 <i>MS slip ring nut M3,5</i>	0,3 - 0,35 Nm
MS-Schleifring Schraube M3 <i>MS slip ring screw M3</i>	0,6 - 0,7 Nm

DECLARATION OF CONFORMITY

Declarations of conformity are available upon request or at <https://www.schill.de/en/downloads/>

SPARE PART ORDER

If you require spare parts, please contact our local distribution partner or give us a ring on 0049 711/ 578807-0 or send a mail at sales@schill.de.

Please have the product number or the part number ready.

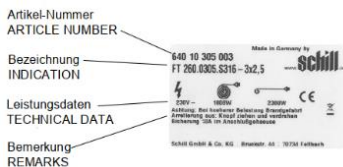

CONTACT

Administration Fellbach

Schill GmbH & Co. KG
Bruck Straße 44
70734 Fellbach
Telefon: [+49 \(0\)711 578807-0](tel:+4907115788070)
Telefax: [+49 \(0\)711 578807-44](tel:+49071157880744)
E-Mail: info@schill.de

Manufacture Laichingen

Schill GmbH & Co. KG
Hirschstr. 81
89150 Laichingen
Telefon: [+49 \(0\)7333 9648-0](tel:+490733396480)
Telefax: [+49 \(0\)7333 9648-44](tel:+4907333964844)
E-Mail: info@schill.de